

TAKEX FLAME PASSIVE SENSOR

FP-2500E

Instruction Manual

We appreciate your purchase of a TAKEX flame Passive sensor. Please read this instruction manual carefully for correct and effective use.

This sensor is designed to detect flames and / or intrusion and to initiate an alarm; it is not a fire-preventing device.

TAKEX is not responsible for damage, injury or losses caused by accident, theft, Acts of God (including inductive surge by lightning), abuse, misuse, abnormal usage, faulty installation or improper maintenance.



- Do not subject the sensor to a strong impact; it may cause damage, malfunction, or a loss in performance. Do not handle the unit in a rough manner.
- Intense flames caused by gas explosion etc. may damage the sensor, without detection.

PRODUCT DESCRIPTION

FP-2500E is a combination sensor; integrating flame and passive infrared sensors into one unit.

FP-2500E features two output modes; "AND" detection mode, and "Individual" detection mode.

- "AND" detection mode initiates flame alarm and passive alarm signal output together when both the flame sensor and passive infrared sensor detect during the selected time.
- "Individual" detection mode initiates flame alarm signal output or passive alarm signal output when either the flame sensor or passive infrared sensor detects.

There is also a "Forced output" operation.

- The flame sensor initiates flame alarm signal after continued detection for a certain period of time even without passive infrared detection in "AND" detection mode.

1 PARTS DESCRIPTION

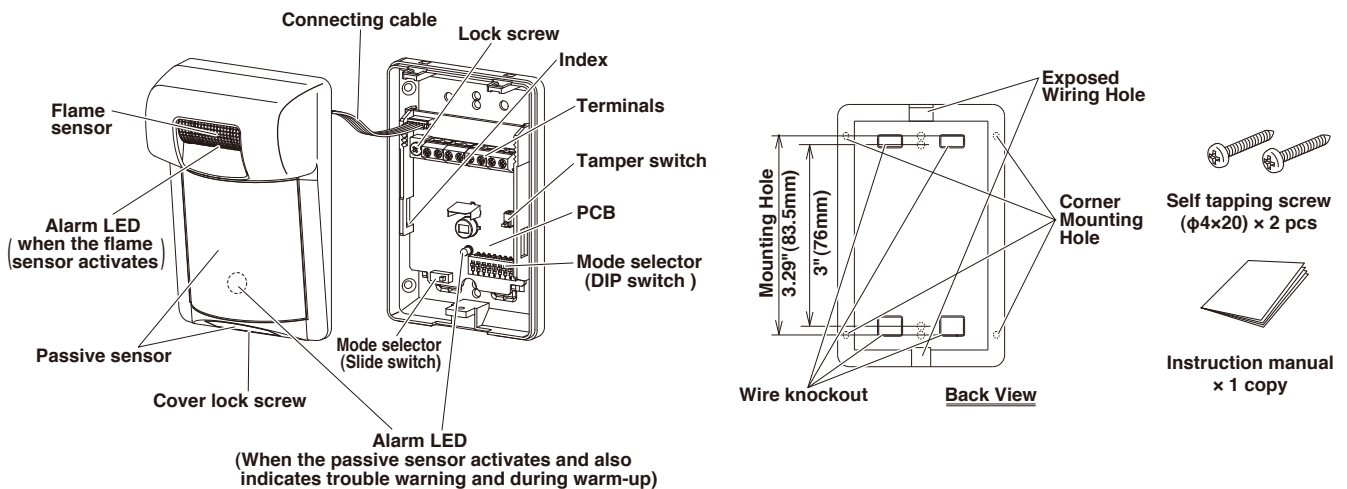

2 PRECAUTIONS **Be sure to observe**

- ⊙ Choose an installation place according to the detection area chart and perform an operation check, taking care to avoid dead angles.
- ⊙ Install the sensor in a location where intruders are more likely to cross the protection zones, rather than approaching head on.
- ⊙ Do not install in the following places.
 - Do not install the sensor outdoors (indoor use only).
 - Do not install it directly on the ceiling. (For ceiling installation, use optional attachment BCW-401.)
 - Do not install it in a location where the sensor or protection zone may be subject to direct or reflected sunlight.
 - Do not install it in high humidity environments place such as bathroom.
 - Do not install it in a site where fire (flame) is usually used such as kitchen.
 - Do not place an object in front of the sensor to shade it from light. (including glass and transparent resin etc)
 - Do not install it in a site where the temperature falls less than +14°F (-10°C) or rises more than +140°F (+60°C).
- ⊙ Do not allow the sensor to get wet, or leave it in humid place. It may cause malfunction.
- ⊙ The passive infrared sensor is designed to detect infrared energy variations caused by the presence of a human body. Therefore, similar variations in conditions in protection area due to other reasons may cause the sensor to create an alarm as it is unable to distinguish between the sources.

◎Flame sensor detects ultraviolet rays contained in several resources.
Therefore, flame sensor may detect other substances emitting ultraviolet rays other than flame. This sensor does not detect burning objects without flame.

- Objects to be detected by flame sensor.
Possible cause of false alarm.
Do not install the sensor near the followings.
- Halogen lamp
 - Electric discharging lamp such as a mercury lamp
 - Electric sterilizer lamp
 - Spark of welding
 - Electric spark (caused by motor, pantograph)
 - Sunlight
 - Electric discharge of lightning bolt
 - High electric field
 - All the objects which emanate ultraviolet rays

- Objects which cannot be detected by flame sensor.
- Flames through the glass or transparent resin
 - Lighting portion of cigarette
 - Burning charcoal or briquet
 - Electric stove
 - Burning object without flames

3 DETECTION AREA

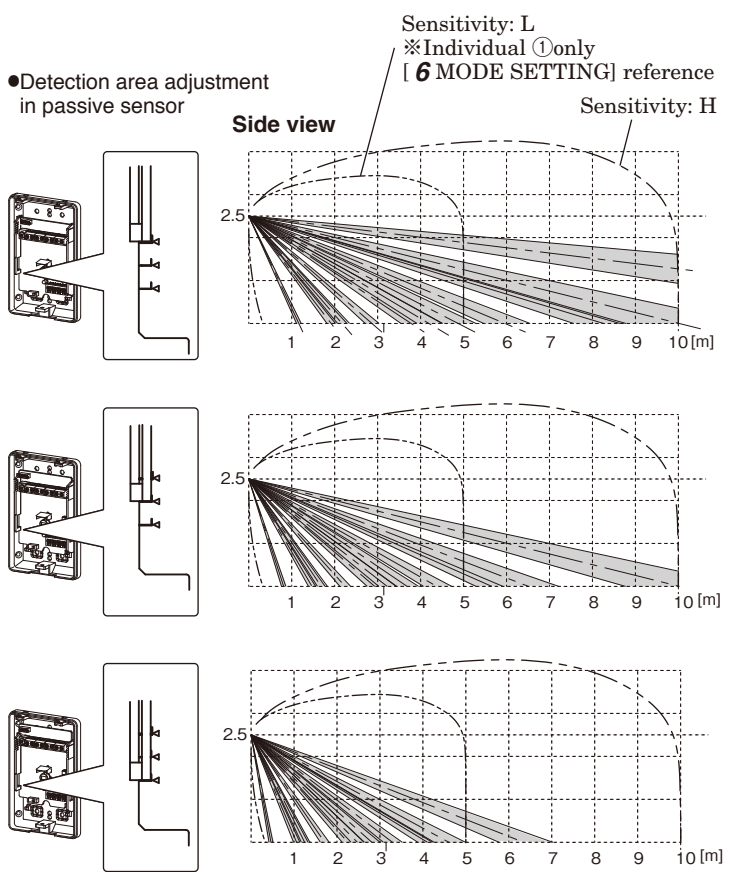
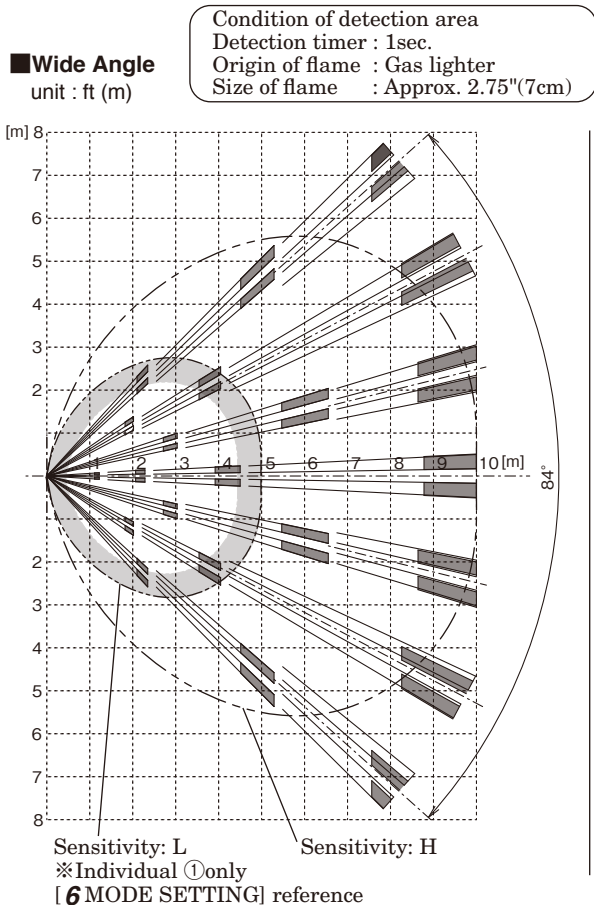

Pet immunity

- The passive sensor is designed not to detect animals under 40lbs. (20kg).
- To maintain maximum pet immunity, the sensor is required to be installed 8.2ft (2.5m) from the floor vertically without changing the factory setting.
- This sensor may detect multiple animals even smaller than 40lbs. in the protection area .
- Area adjustment by PCB will decrease the pet immunity.
- It is therefore recommended to use optional BCW-401 multi purpose mounting bracket if area adjustment is required, which will minimize the performance deterioration of the pet immunity.

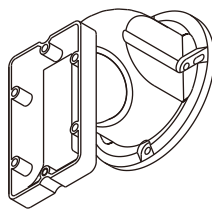

Detection AREA ADJUSTMENT ※Passive sensor only

The detection area can be adjusted to as shown in the side view diagrams above. By loosening the lock screw, and moving the inner PCB upwards, the coverage distance of the sensor can be shortened.
Use the three indexes printed onto the PCB below the left PCB guide rail to adjust the coverage distance. Match each index to the bottom of the guide rail. If the PCB is raised beyond the bottom index, the tamper plunger will not activate, leaving the circuit open in alarm.

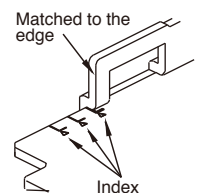

4 WIRING

POWER ALARM① ALARM② TAMPER
10 to 30VDC (FLAME) (PASSIVE) 30V(AC/DC)
20mA 30V(AC/DC) 0.25A 0.1A
non-polarity N.C./N.O. N.C.

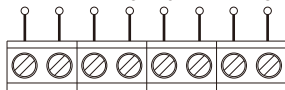

●The maximum wire length, when two or more units are connected, is the above distance divided by the number of units.

[Allowable wiring distance between sensor and power source]

Size of wire used	Distance at 12VDC
AWG 22 (Dia. 0.65mm)	830 ft. (250m)
AWG 20 (Dia. 0.80mm)	1470 ft. (450m)
AWG 18 (Dia. 1.00mm)	2300 ft. (700m)

5 INSTALLATION

1. Loosen cover lock screw and detach the cover.
2. Open knockout hole.
3. Install the base on the wall.
 - * Two mounting pitches are available.
 - * For installation on wall corner, make use of knockouts on the sides.
4. Connect wires to terminals (Refer to 4 WIRING)
5. Attach the cover, and tighten cover lock screw.
 - * Ensure connecting cable is firmly inserted before attaching the cover.

6 MODE SETTING

This sensor operation can be adjusted by mode selector to appropriate application / environment.

●Self-diagnosis

This function is for monitoring troubles such as damage, disconnected wiring.
In case troubles occur, the alarm signal output continues and the alarm LED lights.

(The alarm LED lights even if alarm LED setting is OFF.)

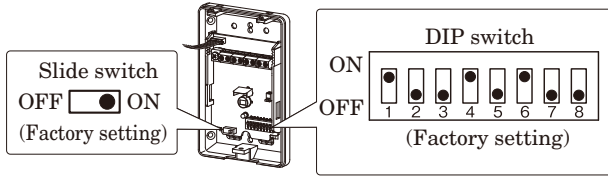

○Alarm LED setting (Slide switch)

Set both flame sensor and passive sensor alarm LED to light ON/OFF.

ON : Enables lighting when the sensor detects.
OFF : LED is always off.

○Alarm memory LED (DIP switch 1) initiates

ON (Auto) : When the sensor initiates an alarm signal, the alarm LED blinks for 3 minutes, and lights for 47 minutes with retrigger function, then the light goes off.
OFF : Disable memory function.

○Detection timer in flame sensor (DIP switch 2)

This sensor initiates flame alarm signal when the flame sensor continues to detect a flame for longer than the set duration of detection timer.

ON : 3 sec
OFF : 1 sec

○Pulse count in passive sensor (DIP switch 3)

ON : 4 / Less sensitive, prevents false alarm caused by temperature fluctuation.
OFF : 2 / Normally set to this position.

○Detection mode setting (DIP switch 4, 5, 6)

"Individual" mode : This mode initiates flame or passive alarm signal output when either of sensors detect.

"AND" mode : This mode initiates flame and passive alarm signal output when both sensors detect during the selected time.

Dip switch setting and operation			Dip switch setting and operation		
Individual①		Mode : Individual detection Flame sensor sensitivity : L	AND③		Mode : 60 sec timer AND detection Forced output : OFF
Individual②		Mode : Individual detection Flame sensor sensitivity : H	AND④		Mode : 60 sec timer AND detection Forced output : ON
AND①		Mode : 10 sec timer AND detection Forced output : OFF	AND⑤		Mode : 10 min timer AND detection Forced output : OFF
AND②		Mode : 10 sec timer AND detection Forced output : ON	AND⑥		Mode : 10 min timer AND detection Forced output : ON

Flame sensor sensitivity

Adjust the size of flame (the strength of ultraviolet ray) to detect.

*The detection distance for "L" is half of that for "H" in case of same flame size

*The sensitivity is fixed to "H" in case of "AND" mode setting.

Forced output

After the flame sensor continued to detect a flame for 30 sec, the flame alarm signal is output even if "AND" mode is selected.

○Alarm① (Flame sensor) contact output changeover setting (DIP switch 7)

ON : N.O.
OFF : N.C.

○Alarm② (Passive sensor) contact output changeover setting (DIP switch 8)

ON : N.O.
OFF : N.C.

7 OPERATION CHECK

It is dangerous to perform operation testing in fire-prohibited environments. Operation tests should only be performed in accordance with site fire safety regulations, under the supervision of responsible persons.

When the power is turned ON, the alarm LED (RED) in passive sensor part starts blinking, which shows warm up status.

Wait approximately 1 minute until blinking ends.

(No blinking operation when the alarm LED is set to OFF) The unit does not issue an alarm during warm up.

Proceed to operation test after warming up completed.

"Individual" mode : ①Walk test within detection area to check if the passive alarm is activated.

②Ignite a lighter etc. for more than setting time within detection area to check if the flame alarm is activated.

"AND" mode : ①Ignite a lighter etc. for longer than setting time while walking within the detection area to ensure both passive alarm and flame alarm are activated.

8 TROUBLESHOOTING

Solve possible problems according to the following table .

If normal operations cannot be restored by these remedies actions, contact either the dealer from whom you bought the unit or TAKEX.

Status	Cause	Remedy
Completely inoperative	①No power supply (Broken wire or improper wire) Low power supply voltage ②Object in front of detection area (Including Glass, Transparent resin) ③Not yet the 1minute warming up completed. (Blinking Alarm LED)	①Check power supply and connecting wire ②Remove the object ③Wait for approx. 1 minute.
Sometimes inoperative	①Improper area setting ②Detection window gets dirty with dust, grease, etc. ③Low power supply voltage	①Relocate the sensor to appropriate position. ②Cleaning up the detection window. ③Set the power supply voltage properly
Activated without flame	①Large electrical noise source such as a radio station or high-voltage wire nearby ②Unexpected ultraviolet rays nearby (Ref: 2, ATTENTION)	①Relocate the sensor to appropriate position. ②Remove the source of ultraviolet rays.or relocate the sensor
Activated without person has passed	①Unstable power supply voltage ②Something moving objects within detection area or too rapid temperature variations ③Large electrical noise source such as a high-voltage wire nearby ④Intense reflection of sun light or car head light shining on the sensor. ⑤Detect the object pass by outside of detection area.	①Set the power supply voltage properly ②Remove the source of variations ③Relocate the sensor to appropriate position. ④Relocate the sensor to appropriate position. ⑤Readjust the detection area
The alarm LED lights, but connected units are inoperative	①Poor contact output connection or broken wire or short circuit. ②Improper alarm output setting ③The connected unit is faulty	①Fix poor connection or broken wire ②Correct the alarm output setting. ③Check the connected unit.
The alarm output continues while LED lighting (passive sensor)	①The connecting cable is disconnected between flame sensor unit and passive sensor unit. ②Sensor unit failure	①Check the status of connecting cable and insert it firmly. ②Ask for repair

9 SPECIFICATIONS

10 EXTERNAL DIMENSIONS

Unit : inch (mm)

Product name	FLAME PASSIVE SENSOR	
Model No.	FP-2500E	
Flame sensor part	Detection system	Ultraviolet rays (Detection wave length 185 to 260nm)
	Detection distance	33'(10m), 2.75'(7cm) lighter flame in front
	Detection area angle	Approx. 120° conically
	Detection setting	Detection timer (1sec, 3sec) Detection sensitivity (H [100%], L[50%]) *Detection sensitivity can be set at only "Individual" mode. *H[100%] is fixed at "AND" mode.
	Alarm LED (RED)	Part of flame sensor • Lighting at alarm (detection time + off delay. Approx. 2 sec.) • Blinking (3 min) and Lighting (47 min) at memory
Passive sensor part	Detection system	Passive infrared
	Detection area	Wide Angle 33'(10m) Max. 29 pairs
	Detection area angle adjustment	3 steps
	Alarm LED (RED)	Part of passive sensor • Lighting at alarm (one shot, Approx. 2 sec.) • Blinking (3 min) and Lighting (47 min) at memory • Lighting at trouble.
Power supply	10V to 30VDC (non-polarity)	
Current consumption	20mA Max.	
Alarm output	Individual mode Flame sensor output (From alarm terminal ①) • Dry contact relay (Semi-Conductor) (N.O./N.C. selectable) • Contact operation : Detection time + off delay. (Approx. 2 sec.) • Contact capacity : 30V (AC/DC) 0.25A Max. (resistive load) Passive sensor output (From alarm terminal ②) • Dry contact relay (Semi-Conductor) (N.O./N.C. selectable) • Contact operation : One shot (Approx. 2 sec.) • Contact capacity : 30V (AC/DC) 0.25A Max. (resistive load) AND mode Alarm signal outputs from alarm terminal ①、②、 when both sensors detect during the selected time. • Dry contact relay (Semi-Conductor) (N.O./N.C. selectable) • Contact operation : Min 2 sec (Max. depends on AND mode timer setting) • Contact capacity : 30V (AC/DC) 0.25A Max. (resistive load)	
	Tamper output	Dry contact relay N.C. (Activated when the front cover is detached) Contact capacity : 30V (AC/DC) 0.1A Max. (resistive load)
Alarm memory	Reset after blinking (3 min) and lighting (47 min) (Operate both flame and passive LED individually)	
Ambient temperature range	5°F to +131°F (-15°C to +55°C) without condensation	
Mounting position	Indoor wall surface (Ceiling with option)	
Connections	Self-up terminal	
Weight	Approx. 120g	
Appearance	Resin	

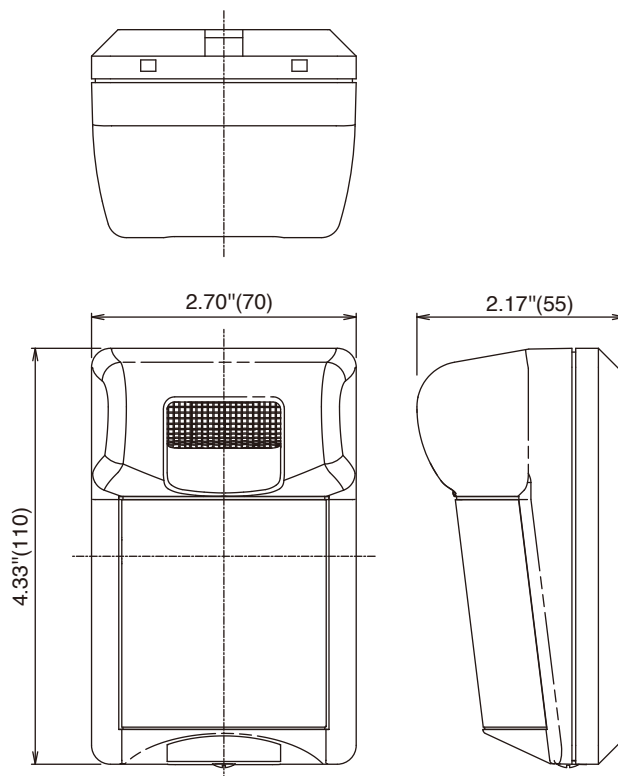

Maintenance

- Check the operation once a week.
- Do not fail to check operation whenever a furniture in the place is moved in and out of detection area.

When housing is stained, remove the stain with a soft cloth using water or mild detergent.
Do not use such chemicals as thinner or benzene to clean the housing.

Limited Warranty :

TAKEX products are warranted to be free from defects in material and workmanship for 12 months from original date of shipment. Our warranty does not cover damage or failure caused by natural disasters, abuse, misuse, abnormal usage, faulty installation, improper maintenance or any repairs other than those provided by TAKEX. All implied warranties with respect to TAKEX, including implied warranties for merchantability and implied warranties for fitness, are limited in duration to 12 months from original date of shipment. During the Warranty Period, TAKEX will repair or replace, at its sole option, free of charge, any defective parts returned prepaid. Please provide the model number of the products, original date of shipment and nature of difficulty being experienced. There will be charges rendered for product repairs made after our Warranty Period has expired.

TAKEX TAKENAKA ENGINEERING CO., LTD.

In Japan

Takenaka Engineering Co., Ltd.
83-1, Gojo-Dori, Sotokan Nishi-iru, Higashino,
Yamashina-ku, Kyoto 607-8156, Japan
Tel : 81-75-501-6651
Fax : 81-75-593-3816
<https://www.takex-eng.co.jp/>

In the U.S.

Takex America Inc.
151, San Zeno WAY
Sunnyvale, CA 94086, USA
Tel : 408-747-0100
Fax : 408-734-1100
<http://www.takex.com>

In Australia

Takex America Inc.
4/15 Howleys Road, Notting Hill,
VIC, 3168
Tel : +61 (03) 9544-2477
Fax : +61 (03) 9543-2342

In the U.K.

Takex Europe Ltd.
Aviary Court, Wade Road,
Basingstoke, Hampshire. RG24 8PE, U.K.
Tel : (+44) 01256-475555
Fax : (+44) 01256-466268
<http://www.takex.com>